



Set flow rates

Easy



For a simple setting

Control components for VAV terminal units, to be mounted on the terminal unit for easy operation

- Simplified ordering and on-site assignment to rooms as selection is based on the nominal size of the duct
- Simple volume flow rate setting without additional device
- Indicator light simplifies functional checking
- With push button for triggering a function test
- Proven technology of the Compact volume flow controllers
- Suitable for constant and variable volume flow rates and q_{vmin} -, q_{vmax} -Switching

General information	2	Variants	7
Function	3	Technical data	9
Specification text	5	Product details	13
Order code	6	Explanation	18

General information

Application

- Electronic volume flow controllers of Type Easy are compact, all-in-one control devices for VAV terminal units
- Dynamic differential pressure transducer, electronic controller, and actuator are fitted together in one casing
- Suitable for different control tasks depending on how the input for the setpoint value signal is used
- The output signals of the room temperature controller, central BMS, air quality controller or similar units control the volume flow rate setpoint
- Override control by means of switches or relays
- Volume flow rate actual value is available as linear voltage signal
- Standard filtration in comfort air conditioning systems allows for use of the controller in the supply air without additional dust protection.

With heavy dust levels in the room

- Install appropriate exhaust air filters upstream, as a partial volume flow is routed through the transducer for volume flow rate measurement.

If the air is contaminated with fluff, sticky components or loaded with aggressive operating fluids

- Do not use any easy controller

Construction

- LMV-D3AL-F for LVC
- 227V-024T-05-013 for LVC
- LMV-D3A-F for TVR
- 227V-024T-05-002 for TVR
- 227V-024T-15-002 for TVJ, TVT
- SMV-D3A for TVT
- LMV-D3A for TZ-Silenzio, TA-Silenzio, TVZ, TVA

- TROVE-024T-05I-DD15 for TVE

Parts and characteristics

- Transducer for dynamic measurement principle
- Mechanical stops for limiting the damper blade positions (not for TVE)
- Actuators with overload protection
- Release button to allow for manual operation (not for TVE)
- Transparent protective cover or terminal cover (for TVE)

Interface

Analogue signal 0 – 10V DC

Control concept

- The volume flow controller works independent of the duct pressure
- Differential pressure fluctuations do not result in permanent volume flow rate changes
- To prevent the control from becoming unstable, a dead band is allowed within which the damper blade does not move.
- The factory set volume flow rate parameters can be altered by the customer

Operating mode

- Operating mode variable volume flow rate, q_{vmin} : Minimum volume flow rate, q_{vmax} : Maximum volume flow rate
- Operating mode Constant value, q_{vmin} : Constant volume flow rate, q_{vmax} : 100 %

Commissioning

- Operating values q_{vmin} , q_{vmax} to be set on site with potentiometer on the outside of the housing without additional adjustment tools

Function

Functional description

A closed control circuit for regulation of the volume flow rate, i.e. measuring - comparing - adjusting, is characteristic of air terminal units.

The volume flow rate is measured by measuring a differential pressure (effective pressure). This is done via a differential pressure sensor. An integrated differential pressure transducer converts the effective pressure into a voltage signal. The volume flow rate actual value is hence available as a voltage signal. The factory setting is such that 10 V DC always corresponds to the

nominal volume flow rate (q_{vnom}).

The volume flow rate setpoint value comes from a higher-level controller (e.g. room temperature controller, air quality controller, central BMS) or from switch contacts. Variable volume flow control results in a value between q_{vmin} and q_{vmax} . It is possible to override the room temperature control, e.g. by a complete shut-off of the duct.

The controller compares the volume flow rate setpoint value to the actual value and controls the integral actuator accordingly. Flow rate parameter q_{vmin} and q_{vmax} can be set on potentiometers.

Principle of operation Easy controller: LVC, TVR, TVJ, TVT, TZ-/TA-Silenzio, TVZ, TVA

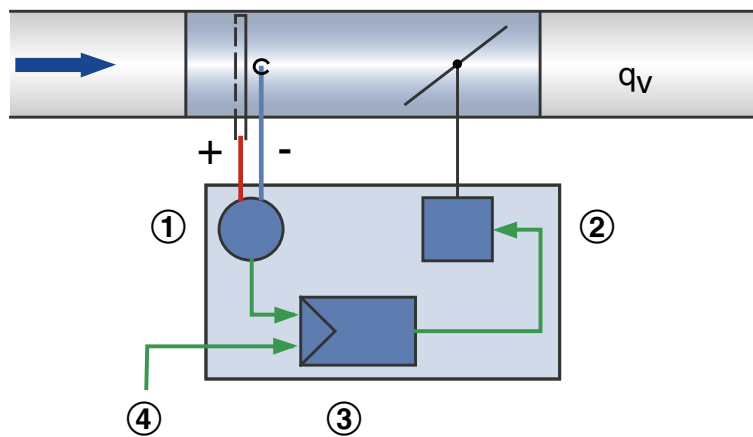

- ① Differential pressure transducer
- ② Actuator

- ③ Volume flow controller
- ④ Setpoint value signal

Principle of operation TVE

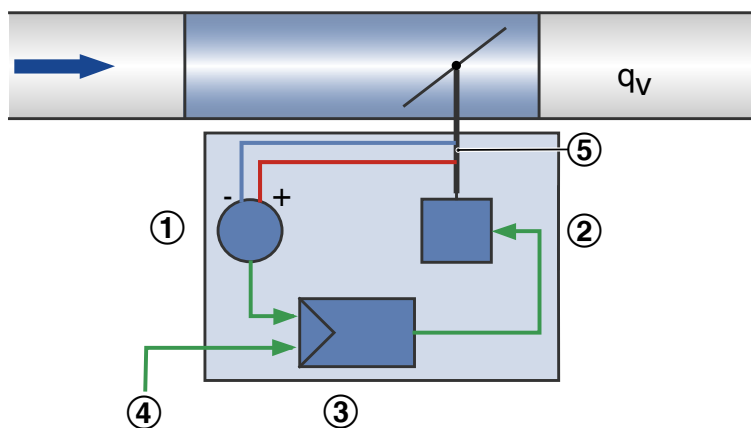

- ① Differential pressure transducer
- ② Actuator
- ③ Volume flow controller

- ④ Setpoint value signal
- ⑤ Shaft with effective pressure channel

The Easy principle

Select nominal size

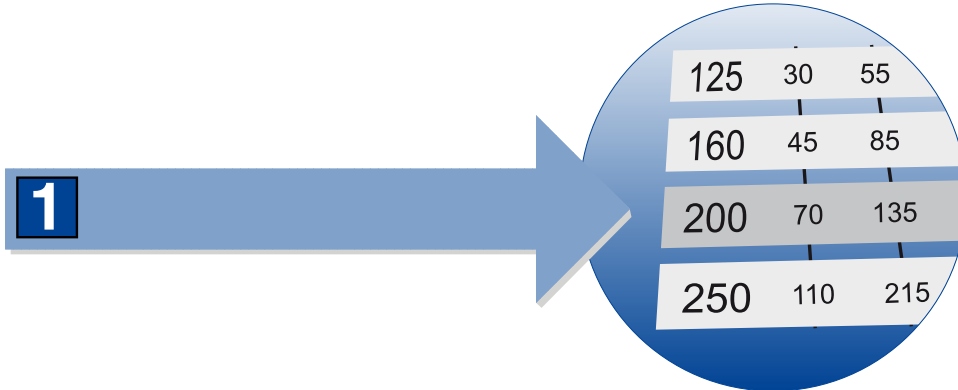

Set flow rates

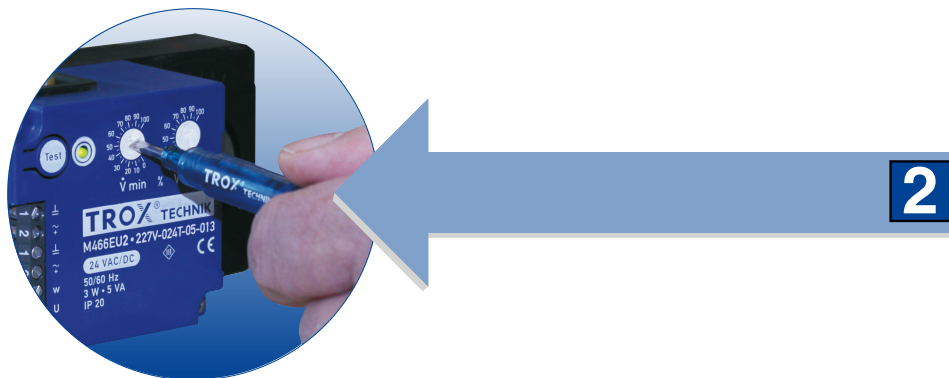

Green light: Ready!

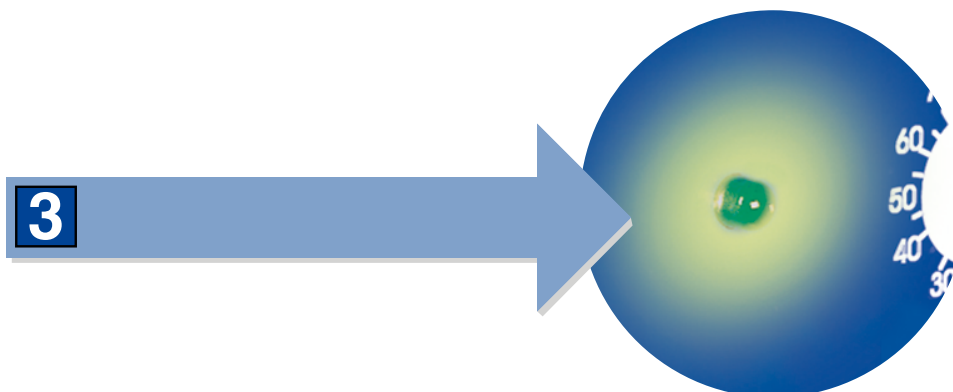

Specification text

This specification text describes the general properties of the product.

Specification text attachment

Easy controller for volume flow rate. Regulation of a constant or variable volume flow rate setpoint. Electronic controller for applying a reference variable and tapping an actual value signal. The actual value signal relates to the nominal volume flow rate such that commissioning and subsequent adjustment are simplified Stand-alone operation or integration into the central building management system.

Application

- Dynamic transmitter for clean air in ventilation and air conditioning systems
- Supply voltage: 24V AC/DC
- Actuator: Integrated; slow-running (Running time 100 – 270 s for 90°)
- Installation orientation: either direction

Connection

- Terminals with additional cover - therefore no additional terminal box required
- Double terminal for supply voltage for easy further wiring of up to 3 controllers

Interface information

- Volume flow setpoint, volume flow actual value
- The actual value signal relates to the nominal volume flow rate such that commissioning and subsequent adjustment are simplified

Special functions

- Clearly visible external indicator light for signalling the functions: Set, not set, and power failure
- Activation q_{vmin} , q_{vmax} , closed, open by external switch contacts/circuitry

Parameter settings

- Parameters specific to VAV terminal unit parameterised at the factory
- Operating values q_{vmin} , q_{vmax} to be set on site with potentiometer on the outside of the housing without additional adjustment tools

Factory settings

- Electronic controller factory-mounted on the terminal unit
- Factory parameter settings
- Functional test under air; certified with sticker



Order code

TVE – D / 200 / D2 / Easy
| | | | |
1 2 5 6 7

1 Type

TVE VAV terminal unit

2 Acoustic cladding

No entry: none

D With acoustic cladding

3 Material**5 Nominal size [mm]**

100

125

160

200

250

Order example: TVE-D/125/D2/Easy

Acoustic cladding

With

Material

Galvanised sheet steel

Nominal size

200 mm

Accessories

Double lip seal both sides

Attachment

Easy controller

6 Accessories

No entry: none

D2 Lip seals on both ends

G2 Matching flanges for both ends

7 Attachments (control component)

Easy Easy controller

Variants

Easy controller



- ① Easy controller
- ② q_{vmax} Potentiometer
- ③ q_{vmin} Potentiometer
- ④ Indicator light
- ⑤ Service button
- ⑥ Connections for effective pressure sensor
- ⑦ Protective cover
- ⑧ Shaft clamp

Application

- LVC
- TVR
- TVJ
- TVT
- TZ-Silenzio
- TA-Silenzio
- TVZ
- TVA

Easy controller TVE

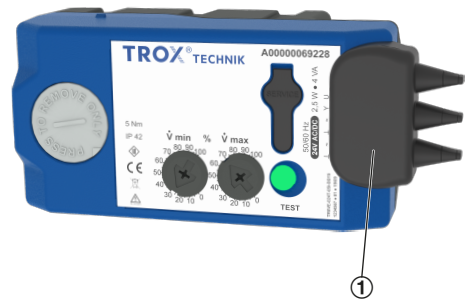
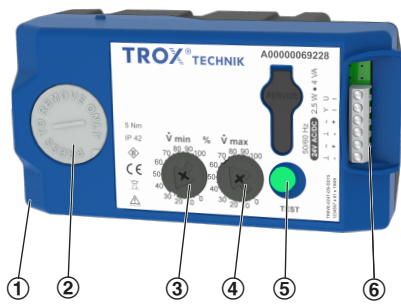

- ① Easy controller
- ② Release button and damper blade position indicator
- ③ q_{vmin} Potentiometer
- ④ q_{vmax} Potentiometer
- ⑤ Test push button and LED to display the operating states
- ⑥ Terminals

- ① Terminal cover

Application

- TVE

Technical data

Easy controllers for VAV terminal units

VAV terminal units	Type	Part number
LVC	LMV-D3AL-F	M466EU1
LVC	227V-024T-05-013	M466EU2
TVE	TROVE-024T-05I-DD15	A00000069228
TVR	LMV-D3A-F	M466ES1
TVR	227V-024T-05-002	M466DC3
TVJ, TVT	227V-024T-15-002	A00000053055
TVT	SMV-D3A	M466ES3
TZ-Silenzio, TA-Silenzio, TVZ, TVA	LMV-D3A	M466ES2

Easy controller LMV-D3AL-F



Supply voltage (AC)	24 V AC \pm 20%, 50/60 Hz
Supply voltage (DC)	24 V DC -10/+20 %
Power rating (AC)	3.5 VA max.
Power rating (DC)	2 W max.
Running time for 90°	120 – 150 s
Setpoint value signal input	0 – 10 V DC, $R_a > 100 \text{ k}\Omega$
Actual value signal output	0 – 10 V DC, max. 0.5 mA
IEC protection class	III (protective extra-low voltage)
Protection level	IP 20
EC conformity	EMC to 2014/30/EU, low voltage to 2014/35/EU

Easy controller 227V-024T-05-013



Supply voltage (AC)	24 V AC \pm 20%, 50/60 Hz
Supply voltage (DC)	24 V DC \pm 20 %
Power rating (AC)	5 VA max.
Power rating (DC)	3 W max.
Running time for 90°	100 s
Setpoint value signal input	0 – 10 V DC, Ra > 100 k Ω
Actual value signal output	0 – 10 V DC, max. 0.5 mA
IEC protection class	III (protective extra-low voltage)
Protection level	IP 20
EC conformity	EMC to 2014/30/EU

Easy controller TROVE-024T-05I-DD15



Supply voltage (AC)	24 V AC \pm 20%, 50/60 Hz
Supply voltage (DC)	24 V DC \pm 20 %
Power rating (AC)	4 VA max.
Power rating (DC)	2.5 W max.
Running time for 90°	100 s
Setpoint value signal input	0 – 10 V DC, Ra > 100 k Ω
Actual value signal output	0 – 10 V DC, max. 0.5 mA
IEC protection class	III (protective extra-low voltage)
Protection level	IP 42 (with attached terminal cover)
EC conformity	EMC to 2014/30/EU

Easy controller LMV-D3A



Supply voltage (AC)	24 V AC \pm 20%, 50/60 Hz
Supply voltage (DC)	24 V DC -10/+20 %
Power rating (AC)	5 VA max.
Power rating (DC)	2.5 W max.
Running time for 90°	110 – 150 s
Setpoint value signal input	0 – 10 V DC, Ra > 100 k Ω
Actual value signal output	0 – 10 V DC, max. 0.5 mA
IEC protection class	III (protective extra-low voltage)
Protection level	IP 20
EC conformity	EMC to 2014/30/EU

Easy controller 227V-024T-05-002



Supply voltage (AC)	24 V AC \pm 20%, 50/60 Hz
Supply voltage (DC)	24 V DC \pm 20 %
Power rating (AC)	5 VA max.
Power rating (DC)	3 W max.
Running time for 90°	100 s
Setpoint value signal input	0 – 10 V DC, Ra > 100 k Ω
Actual value signal output	0 – 10 V DC, max. 0.5 mA
IEC protection class	III (protective extra-low voltage)
Protection level	IP 20
EC conformity	EMC to 2014/30/EU

Easy controller 227V-024T-15-002



Supply voltage (AC)	24 V AC \pm 20%, 50/60 Hz
Supply voltage (DC)	24 V DC \pm 20 %
Power rating (AC)	5 VA max.
Power rating (DC)	3 W max.
Running time for 90°	150 – 270 s
Setpoint value signal input	0 – 10 V DC, $R_a > 100 \text{ k}\Omega$
Actual value signal output	0 – 10 V DC, max. 0.5 mA
IEC protection class	III (protective extra-low voltage)
Protection level	IP 20
EC conformity	EMC to 2014/30/EU

Easy controller SMV-D3A



Supply voltage (AC)	24 V AC \pm 20%, 50/60 Hz
Supply voltage (DC)	24 V DC -10/+20 %
Power rating (AC)	6 VA max.
Power rating (DC)	3 W max.
Running time for 90°	110 – 150 s
Setpoint value signal input	0 – 10 V DC, $R_a > 100 \text{ k}\Omega$
Actual value signal output	0 – 10 V DC, max. 0.5 mA
IEC protection class	III (protective extra-low voltage)
Protection level	IP 20
EC conformity	EMC to 2014/30/EU

Product details

Different terminal designation for Easy controller TVE

- Terminal without numbering
- Symbol Y instead of w

Terminal connections

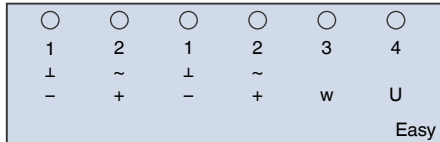

Setpoint value signal 0 – 20 mA

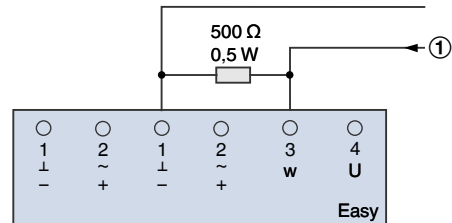

- 1 ⊥, -: Ground
- 2 ~, +: Supply voltage 24 V
- 3 w: Setpoint value signal 0 – 10 V DC
- 4 U: Actual value signal 0 – 10 V DC

① Setpoint value signal 0 – 20 mA

Variable volume flow control

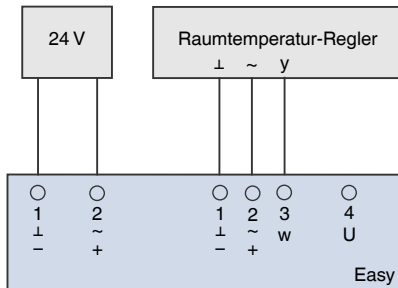

The supply voltage and the remote room temperature controller must be connected as shown.

Constant volume flow control

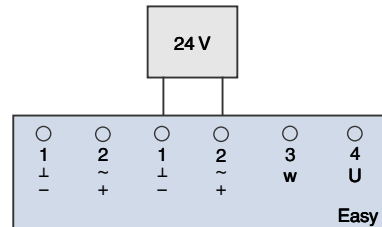

As soon as the 24 V supply voltage has been applied, the controller uses the set q_{vmin} value as a constant volume flow rate.

Switching for one controller $q_{v,min}/q_{v,max}$

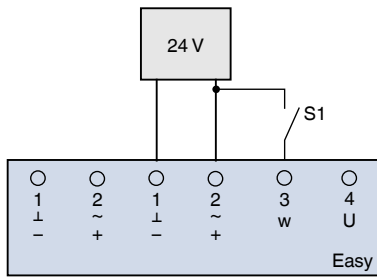

Override control OPEN/CLOSED

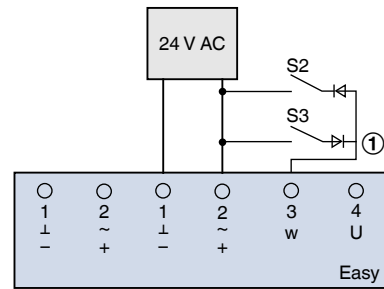

Switch S1 enables switching between the two constant volume flow rates $q_{v,min}$ and $q_{v,max}$.

Switch S1 open: $q_{v,min}$

Switch S1 closed: $q_{v,max}$

When several Easy controllers are connected in parallel, switch S1 must be used as changeover switch and the contact for $q_{v,min}$ operation must be connected to the ground (terminal 1).

① Diode 1N 4007

External switches (volt-free contacts) can be used to OPEN or CLOSE the damper blade, thereby overriding other control settings (only for AC voltage).

Switch S2 closed: Damper blade CLOSED

Switch S3 closed: Damper blade OPEN

All override controls can be combined both with each other and with the different switching options.

Easy controllers connected in parallel

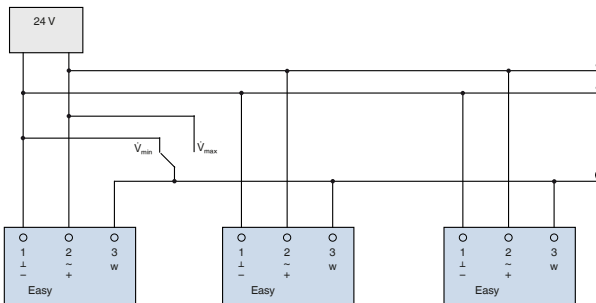

Characteristics

Characteristic of the setpoint value signal

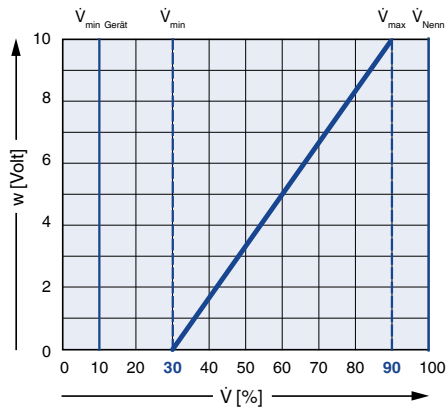

Calculation of the volume flow rate setpoint value

$$\dot{V}_{\text{Soll}} = \frac{w}{10} (\dot{V}_{\text{max}} - \dot{V}_{\text{min}}) + \dot{V}_{\text{min}}$$

Characteristic of the actual value signal

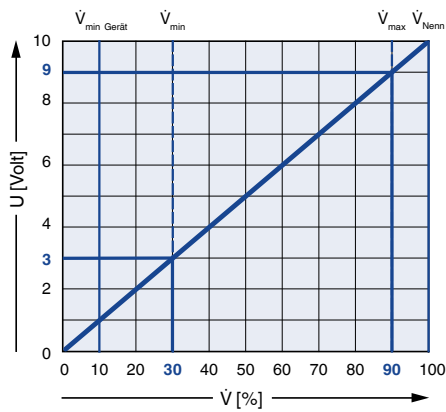

Calculation of the volume flow rate actual value

$$\dot{V}_{\text{Ist}} = \frac{U}{10} \dot{V}_{\text{Nenn}}$$

Commissioning

- Use the potentiometer to set the minimum or maximum volume flow rate on site
- Take the adjustment value from the volume flow rate scale (sticker on each VAV terminal unit)
- Comply with the volume flow rate control range, do not set a volume flow rate which is below the minimum flow rate
- Volume flow rate control range TVE: 4 – 100 %
- Volume flow rate range of LVC, TVR, TZ-Silenzio, TA-Silenzio, TVZ and TVA: 10 – 100%
- Volume flow rate range of TVJ and TVT: 20 – 100%
- Once the VAV terminal unit has been installed and wired, and the volume flow rate has been set, the unit is ready for operation
- Only briefly remove the transparent protective cap or terminal cover of the Easy regulator during wiring and commissioning

Volume flow rate scale for TVR-Easy

Variable volume flow control

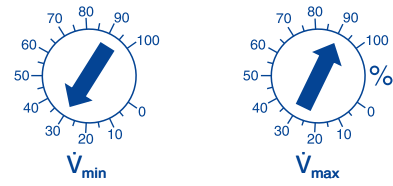
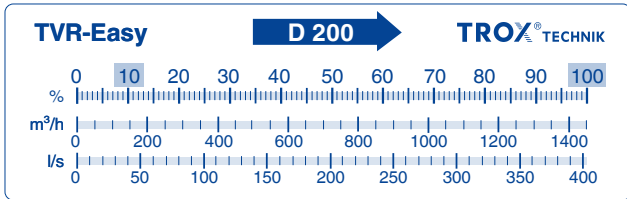

Each VAV terminal unit with Easy controller carries a sticker with a volume flow rate scale to determine the setting values at the customer's site (see example: TVR Easy, nominal size 200). The percentages refer to the control range that can be used.

The required volume flow rates must be set by others. If q_{vmin} higher than q_{vmax} is set, then q_{vmin} as a constant volume flow rate even if a setpoint value signal is transmitted.

If q_{vmin} is set on 0 %, then control is between shut-off and q_{vmax} . If the setpoint value signal falls below 0.5 V DC, the damper blade closes (shut-off).

Constant volume flow control

Control input signal from the central BMS

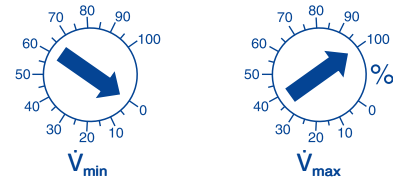
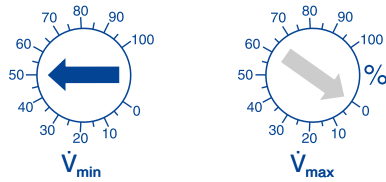

The constant volume flow rate is set using the q_{vmin} potentiometer. The setting of the q_{vmax} potentiometer is in this case irrelevant.

To have the central BMS determine the volume flow rate, the q_{vmin} potentiometer must be set to 0 % and the q_{vmax} potentiometer to 100 %. If the setpoint value signal falls below 0.5 V DC, the damper blade closes (shut-off). In practice, falling below 0.5 V DC is not always safe to realise. This is why override control is recommended for shut-off.

Factory setting

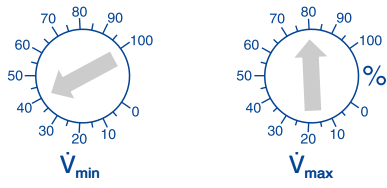

Units are delivered with settings $q_{v\min} = 40\%$ and $q_{v\max} = 80\%$ set.

Explanation

q_{vnom}
[m³/h]; [l/s]

Nominal volume flow rate (100 %): The value depends on product type and nominal size. Values are published on the internet and in technical leaflets, and stored in the Easy Product Finder design software. Reference value for calculating percentages (e.g. q_{vmax}). Upper limit of the setting range and maximum volume flow rate setpoint value for the VAV terminal unit.

$q_{vmin Unit}$
[m³/h]; [l/s]

Technically possible minimum volume flow rate: The value depends on product type, nominal size and control component (attachment). Values are stored in the Easy Product Finder design software. Lower limit of the setting range and minimum volume flow rate setpoint value for the VAV terminal unit. Depending on the controller, setpoint values below $q_{vmin unit}$ (if q_{vmin} equals zero) may result in unstable control or shut-off.

q_{vmax}
[m³/h]; [l/s]

Upper limit of the operating range for the VAV terminal unit that can be set by customers: q_{vmax} can only be smaller than or equal to q_{vnom} . In case of analogue signalling to volume flow controllers (which are typically used), the set maximum value (q_{vmax}) is allocated to the setpoint signal maximum (10 V) (see characteristic).

q_{vmin}

[m³/h]; [l/s]

Lower limit of the operating range for the VAV terminal unit that can be set by customers: q_{vmin} should be smaller than or equal to q_{vmax} . Do not set q_{vmin} smaller than $q_{vmin unit}$, otherwise the control may become unstable or the damper blade may close. q_{vmin} may equal zero. In case of analogue signalling to volume flow controllers (which are typically used), the set minimum value (q_{vmin}) is allocated to the setpoint signal minimum (0 or 2 V) (see characteristic).

q_v
[m³/h]; [l/s]

Volume flow rate

Δ_{pst}
[Pa]

Static differential pressure

$\Delta_{pst min}$
[Pa]

Static differential pressure, minimum: The static minimum differential pressure is equal to the pressure loss of the VAV controller when the damper blade is open, caused by flow resistance (damper blade). If the pressure on the VAV controller is too low, the setpoint volume flow rate may not be achieved, not even when the damper blade is open. Important factor in designing the ductwork and in rating the fan including speed control. Sufficient differential pressure must be ensured for all operating conditions and for all controllers, and the measurement point or points for speed control must have been selected accordingly to achieve this.