

UPK

Avtreksrist med ATK plenumsammer

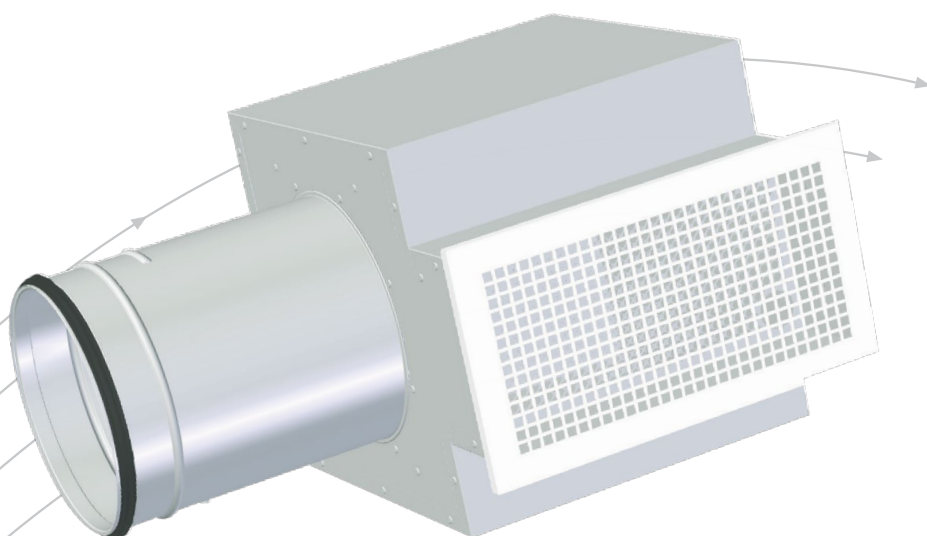

- Tilpassede størrelser, BxH varianter
- Leveres med eller uten kammer
- Rist med montasjeramme
- Demonterbart spjeld for rensing
- Lydabsorbent i polyester i ATK kammer

TROX[®] TECHNIK

 **Auranor**

TROX Auranor Norge AS

Auranorvegen 6
2770 Jaren

Telefon 61 31 35 00

e-post: firmapost@auranor.no
www.trox.no

UPK (BxH)



ANVENDELSE

UPK er en avtrekksrist for veggmontasje. Den leveres etter ønsket mål og kan derfor tilpasses forskjellige utsparringsmål eller bygningsmessige kammerer.

UTFØRELSE

UPK har kvadratisk perforering. Den leveres med festehull og lakkerte skruer. Rister over 2 m² deles.

MATERIALE OG OVERFLATEBEHANDLING

Rista er produsert i stål og lakkert i RAL 9003 - glans 30. Rista leveres med polyuretan tettningslist. Andre materialer og farger leveres på forespørsel.

HURTIGVALG

Ved prosjektering av UPK BxH bør ikke kanalhastigheten overstige 3m/s. Dette for å unngå lydproblemer

BESTILLINGSKODE, UPK

Produkt **UPK - 800 - 900 / 0** SL = Spesiallakk
B = Bredde f.o.m. 100, maks. 1850 (850)
H = Høyde f.o.m. 100, maks 850 (1850)
(Maks areal totalt; 2 m² per rist)

Eksempel:
UPK-800-900 / 0
Forklaring:
UPK bredde: 800 og høyde: 900

MÅL OG VEKT, UPK

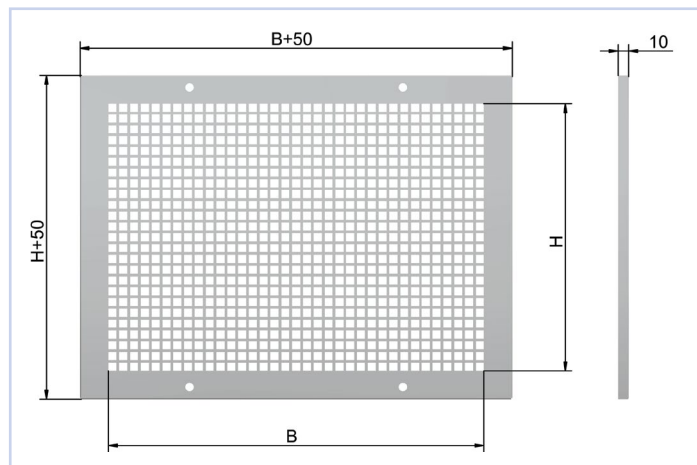

Figur 1

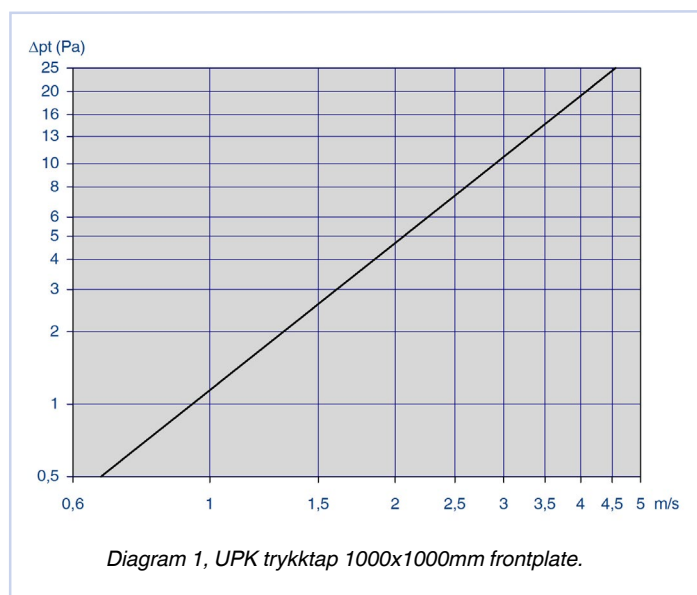

UPK rist

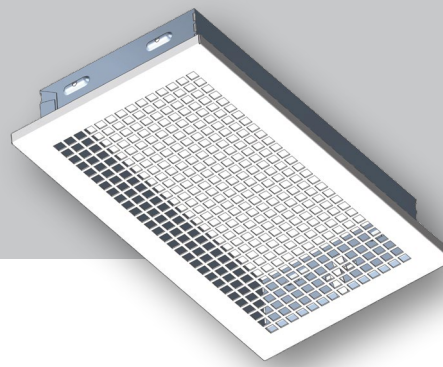

ANVENDELSE

UPK-R er en rektangulær avtrekksrist for innfelling i vegg eller himling. UPK-H er tilpasset T-profilhimmel, 600 x 600.

UTFØRELSE

UPK-R-rista har kvadratisk perforering og har påmontert ramme for innfesting i ATK-kammer eller kanalstuss.

MATERIALE OG OVERFLATEBEHANDLING

UPK-R rist og ramme er produsert i stål og leveres lakkert i RAL 9003 - glans 30. På forespørsel kan UPK-R-rista leveres i andre materialer og/eller farger.

HURTIGVALG

UPK-R B x H	[m³/h]		
	30dB(A)	35dB(A)	40dB(A)
200-100	200	245	300
300-100	315	390	455
400-100	395	470	575
500-100	460	575	685
300-150	450	560	675
400-150	520	655	800
500-150	700	885	1060
400-200	790	970	1190
500-200	965	1160	1420
600-200	1090	1315	1620
500-300	1270	1600	1945
600-300	1440	1800	2160

Tabell 1, tabellen viser luftmengder ved oppgitt lydeffektnivå.

MÅL OG VEKT, UPK

UPK-R	
B x H	Vekt [kg]
200x100	0,50
300x100	0,55
400x100	0,60
500x100	0,65
300x150	0,70
400x150	0,75
500x150	0,95
400x200	1,00
500x200	1,15
600x200	1,20
500x300	1,50
600x300	1,65

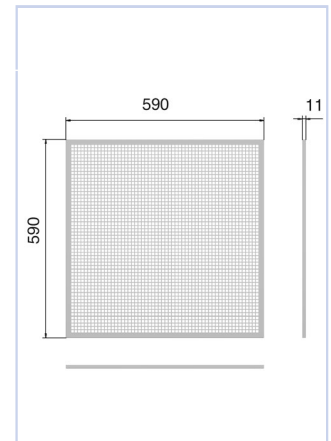

Figur 2, UPK-H

Tabell 2

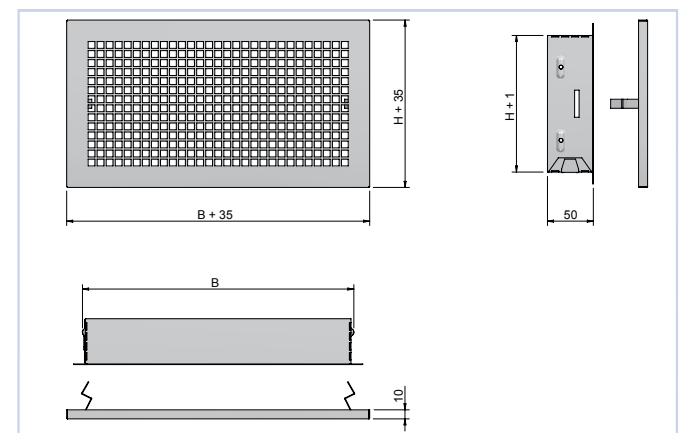

Figur 3, UPK-R

BESTILLINGSKODE, UPK-R

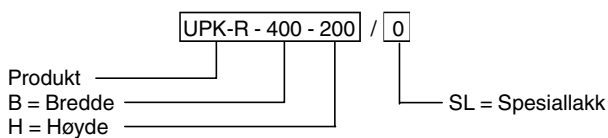

Eksempel:
UPK-R-400-200 / 0-0

Forklaring:
UPK-R avtrekksrist bredde 400 og høyde 200.

BESTILLINGSKODE, UPK-H

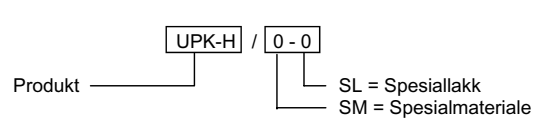

Eksempel:
UPK-H / 0-0

Forklaring:
UPK-H avtrekksrist for T-profilhimmel 600x600.

BESTILLINGSKODE, ATK

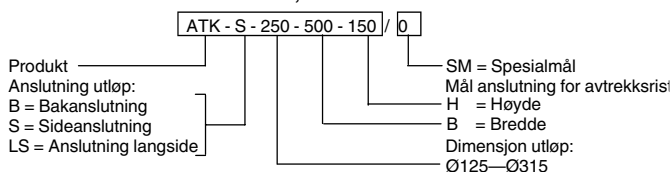

Eksempel:
ATK-S-250-500-150/0

Forklaring:
ATK avtrekkskammer med sideanslutning og utløp Ø250, bredde 500 og høyde 150 for anslutning av rist.

BESTILLINGSKODE, ATK-H

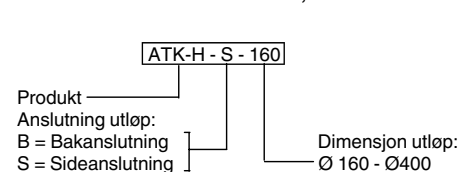

Eksempel:
ATK-H-S-160

Forklaring:
ATK-H avtrekkskammer for profilhimmel 600x600 med sideanslutning Ø160.

UPK-rist med ATK kammer

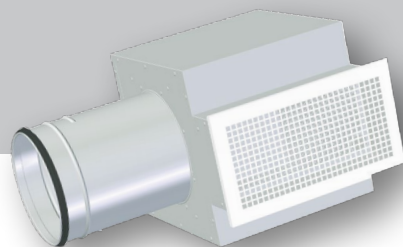

ANVENDELSE

ATK-kammer benyttes for å gi bedre lyddemping, samt reguleringsmulighet. Kammeret er et rektangulært kammer med demonterbart spjeld som gir tilgang til anslutningskanal.

UTFØRELSE

ATK-kammer har spjeld for innregulering, ATK-B, S og LS har måleuttak. Kammeret er isolert med en lydabsorbent i polyester.

MATERIALE OG OVERFLATEBEHANDLING

ATK-kammer er produsert i galvanisert stål og innvendig isolert med lydabsorbent i polyester. Anslutningen har EPDM gummipakning.

HURTIGVALG, UPK-H

ATK-H Kammer		UPK-H	m ³ /h		
Dim.	Ansl.	Dim.	25 dB(A)	30 dB(A)	35 dB(A)
160	B	600 x 600	133	169	238
160	S	600 x 600	126	234	353
200	B	600 x 600	209	299	418
200	S	600 x 600	201	324	436
250	B	600 x 600	338	504	648
250	S	600 x 600	346	594	756
315	B	600 x 600	475	774	1415
315	S	600 x 600	810	947	1098
400*	B	600 x 600	1060	1302	1600
400*	S	600 x 600	1019	1253	1540

Tabell 3, tabellen viser luftmengde ved oppgitt lydeffektnivå og 50 Pa totaltrykktap. * = Ø400 er uten spjeld / kapasitet ved oppgitt lydnivå

HURTIGVALG

ATK kammer		UPK-R	m ³ /h		
Dim.	Ansl.	B x H	25 dB(A)	30 dB(A)	35 dB(A)
125	B	200x100	68	119	180
125	S	200x100	86	133	184
125	LS	200x100	68	119	184
160	B	300x100	-	126	256
160	S	300x100	126	187	263
160	LS	300x100	130	212	281
160	B	400x100	137	198	295
160	S	400x100	126	205	295
160	LS	400x100	133	202	320
200	B	500x100	252	360	454
200	S	500x100	216	284	392
200	LS	500x100	-	270	396
200	B	300x150	220	324	432
200	S	300x150	216	317	421
200	LS	300x150	191	306	436
250	B	400x150	-	414	533
250	S	400x150	-	436	580
250	LS	400x150	360	493	587
250	B	500x150	-	468	684
250	S	500x150	-	436	648
250	LS	500x150	-	446	655
250	B	400x200	-	529	738
250	S	400x200	324	450	648
250	LS	400x200	335	446	601
315	B	500x200	468	828	1098
315	S	500x200	461	720	918
315	LS	500x200	454	713	918
315	B	600x200	720	1098	1368
315	S	600x200	720	972	1260
315	LS	600x200	720	900	1260
315	B	500x300	648	900	1098
315	S	500x300	-	774	1116
315	LS	500x300	468	774	1116
315	B	600x300	846	972	1152
315	S	600x300	648	900	1224
315	LS	600x300	612	774	936

Tabell 4, tabellen viser luftmengde ved oppgitt lydeffektnivå og 50 Pa totaltrykktap.

UPK rist med ATK kammer

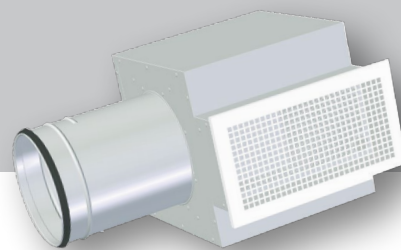

MÅL OG VEKT ATK, S OG LS

ATK	BFxHF	D	A	Vekt[kg]
125	200x100	124	180	2,8
160	300x100	159	215	4,3
160	400x100	159	215	5,3
200	500x100	199	305	8,5
200	300x150	199	305	6,5
250	400x150	249	355	9
250	500x150	249	355	10,4
250	400x200	249	355	9,5
315	500x200	314	415	12,7
315	600x200	314	415	14
315	500x300	314	415	12,8
315	600x300	314	415	13,7

Tabell 5

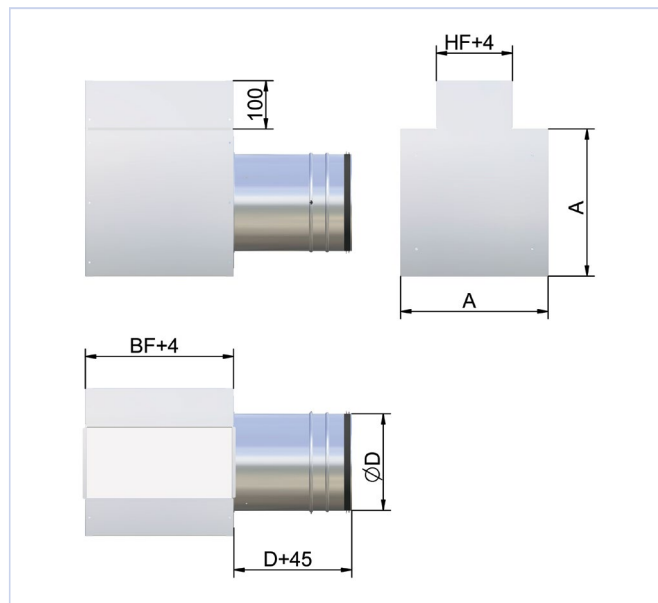

Figur 5, ATK-S

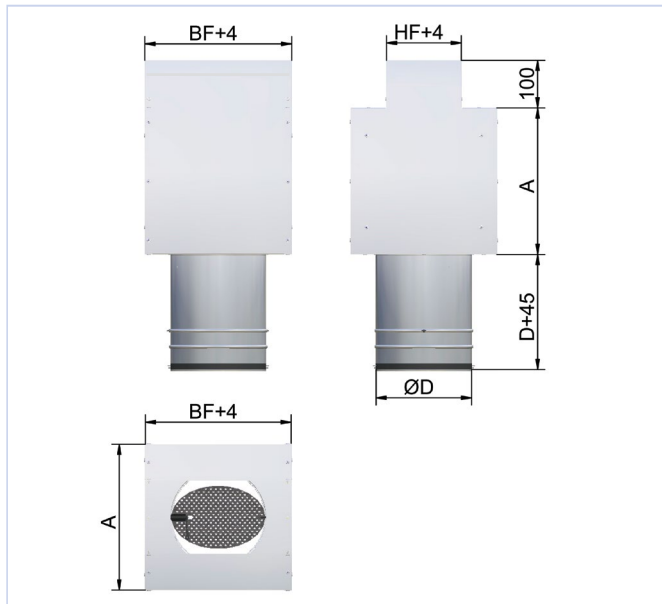

Figur 4, ATK-B

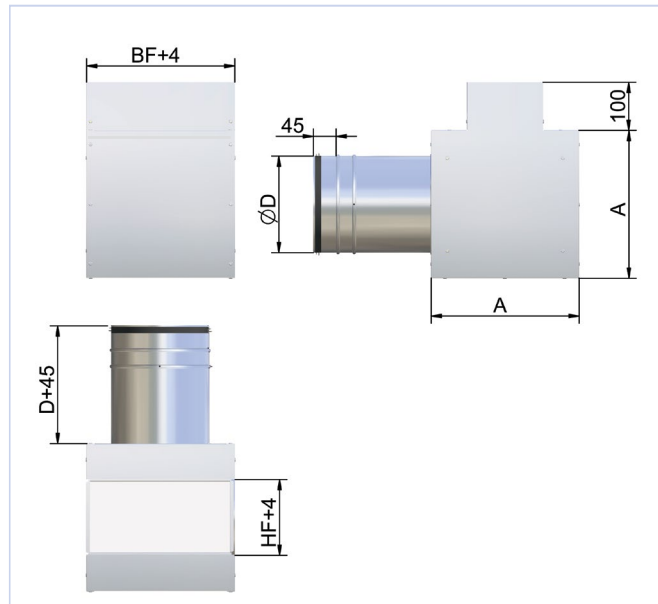

Figur 6, ATK-LS

UPK-H med ATK kammer

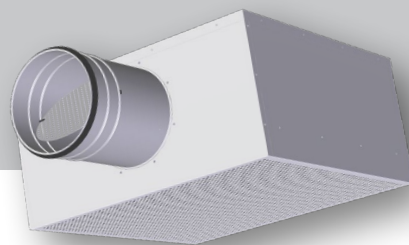

MÅL OG VEKT ATK-H-S/B

ATK-H-S/B			
Dim.	D	H	Vekt[kg]
160	159	245	7,8
200	199	285	8,2
250	249	335	8,9
315	314	400	10,1
400	399	485	11,2

Tabell 6

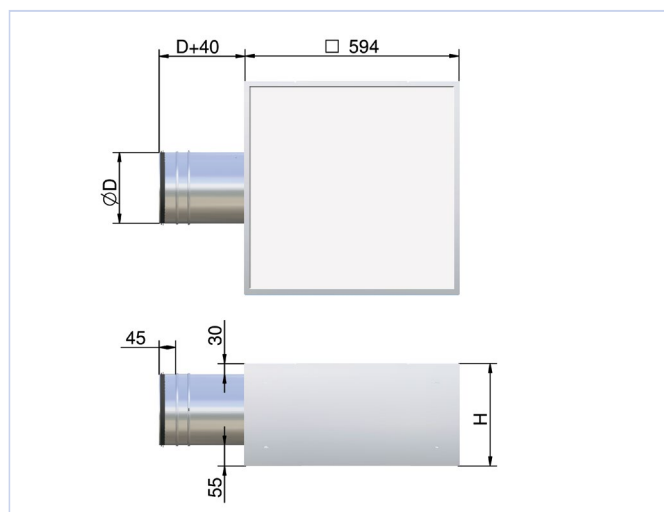

Figur 7, ATK-H-S

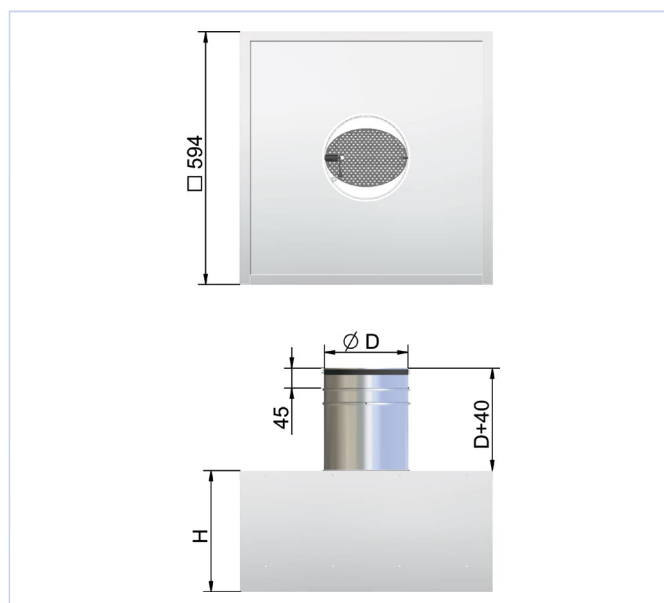

Figur 8, ATK-H-B

AKUSTISK DOKUMENTASJON

I diagrammene er det oppgitt summert A-veid lydeffektnivå fra ventil, L_{WA} . Korreksjonsfaktorene i tabell 8, side 15, benyttes for å beregne avgitt frekvensfordelt lydeffektnivå, $L_W = L_{WA} + KO$. Lydtrykknivå i et rom med absorpsjon tilsvarende 10m^2 Sabine vil være 4 dB lavere enn avgitt lydeffektnivå.

Eksempel:

I et lokale skal det trekkes av 80 l/s romluft, og det velges en UPK-R 300x100 og ATK med bakanslutning. Romdempningen er 4 dB, og det er beregnet at ventilens spjeld skal strupes 20 Pa. Av diagram 5 finner vi at $L_{WA} = 33\text{dB(A)}$ ved åpent spjeld og 21 Pa totaltrykktap.

Vi ønsker å finne:

- Avgitt lydeffektnivå fra ventilen i 250 Hz ved åpent spjeld.
- A-veid lydtrykknivå i rommet med åpent spjeld.
- A-veid lydtrykknivå i rommet ved strupt spjeld.
- Avgitt lydeffektnivå fra ventilen i 250 Hz ved strupt spjeld.

Løsning:

a) Tabell 8 viser at korreksjonsfaktoren for 250 Hz er -2 dB.

L_W i 250 Hz blir da: $L_{WA} + KO = 33 + (-2) = 31\text{ dB}$

b) Med 4 dB romdempning blir lydtrykknivået i rommet:
 $31 - 4 = 27\text{ dB(A)}$

c) Med 20 Pa struping kommer vi opp til 41 Pa, og diagrammet viser at L_{WA} øker med 3dB. Lydtrykknivået blir da
 $27 + 3 = 30\text{ dB(A)}$

d) Av tabell 8 finner vi at korreksjonsfaktoren for 250 Hz er -6 ved stengt spjeld og -2 ved åpent spjeld. Plasseringen av vårt driftspunkt tilsier at vi bruker KO-faktor -3dB.

Avgitt lydeffektnivå L_W i 250 Hz blir da:

Avgitt lydeffektnivå L_W i 250 Hz blir da:

$L_{WA} + KO = 33 + (-3) = 30\text{ dB(A)}$

DIMENSJONERINGSDIAGRAM

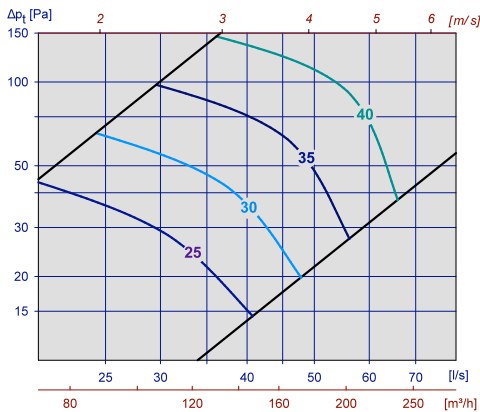

Diagram 2, UPK-R m / ATK-B 200x100 Ø125

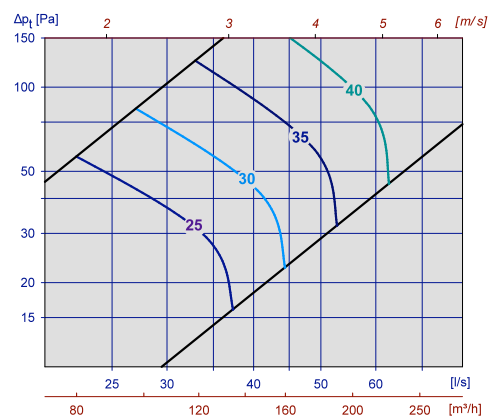

Diagram 3, UPK-R m / ATK-S 200x100 Ø125

UPK

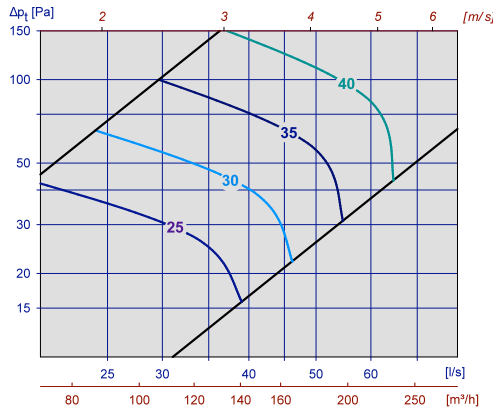

Diagram 4, UPK-R m / ATK-LS 200x100 Ø125

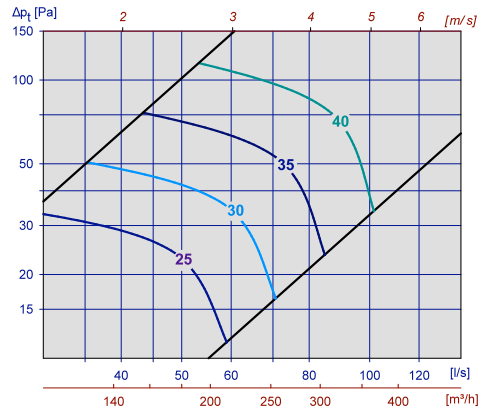

Diagram 5, UPK-R m / ATK-B 300x100 Ø160

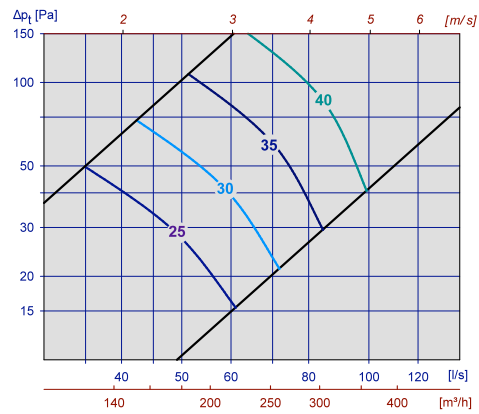

Diagram 6, UPK-R m / ATK-S 300x100 Ø160

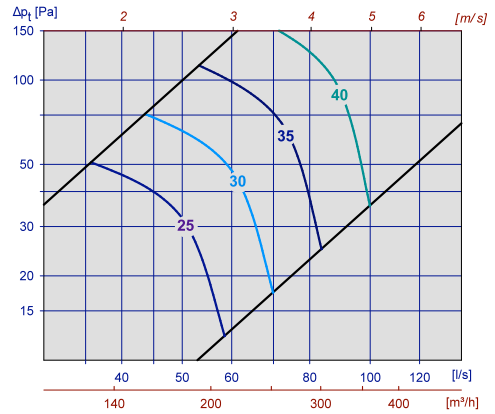

Diagram 7, UPK-R m / ATK-LS 300x100 Ø160

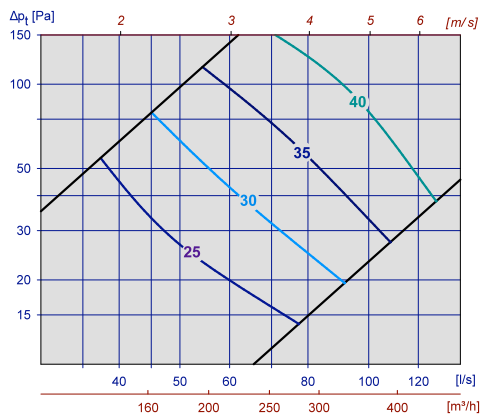

Diagram 8, UPK-R m / ATK-B 400x100 Ø160

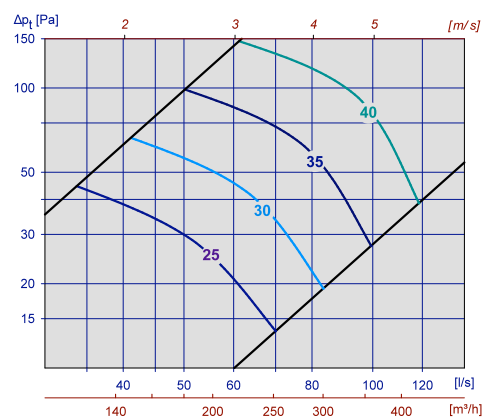

Diagram 9, UPK-R m / ATK-S 400x100 Ø160

UPK

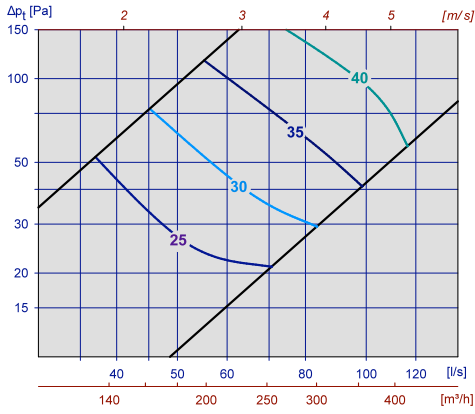

Diagram 10, UPK-R m / ATK-LS 400x100 Ø160

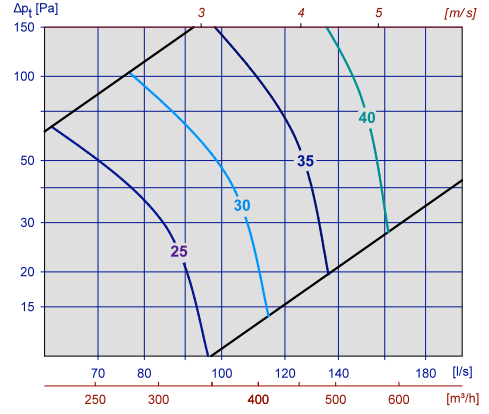

Diagram 11, UPK-R m / ATK-B 500x100 Ø160

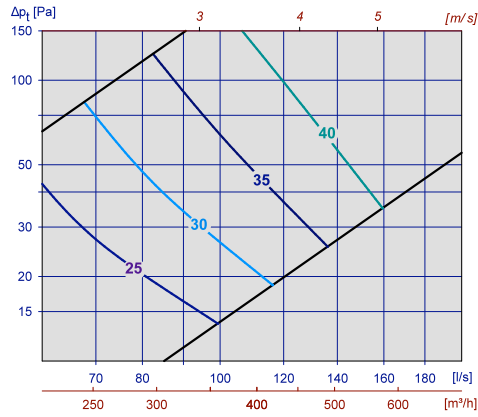

Diagram 12, UPK-R m / ATK-S 500x100 Ø200

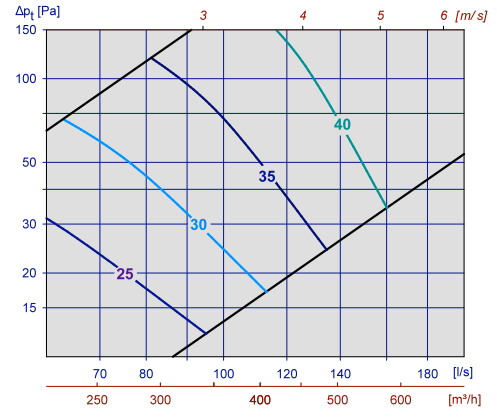

Diagram 13, UPK-R m / ATK-LS 500x100 Ø200

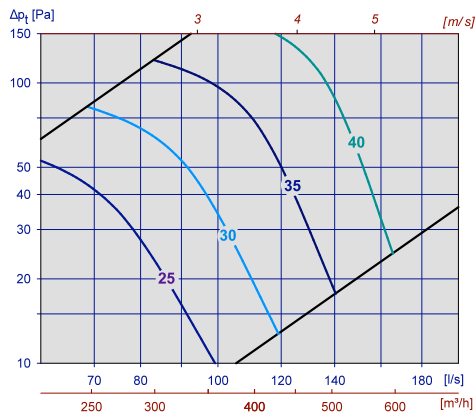

Diagram 14, UPK-R m / ATK-B 300x150 Ø200

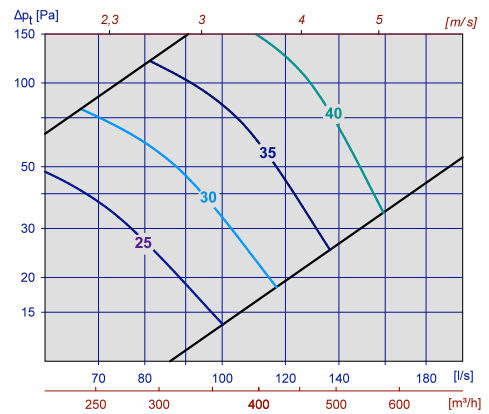

Diagram 15, UPK-R m / ATK-S 300x150 Ø200

UPK

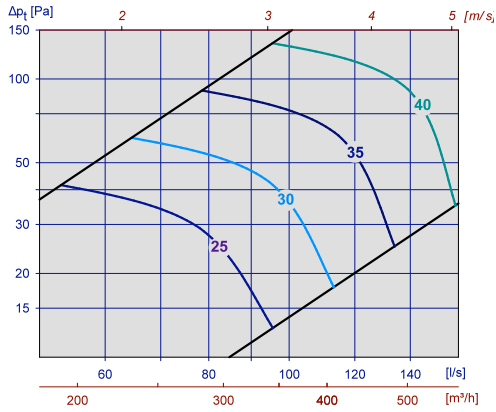

Diagram 16, UPK-R m / ATK-LS 300x150 Ø200

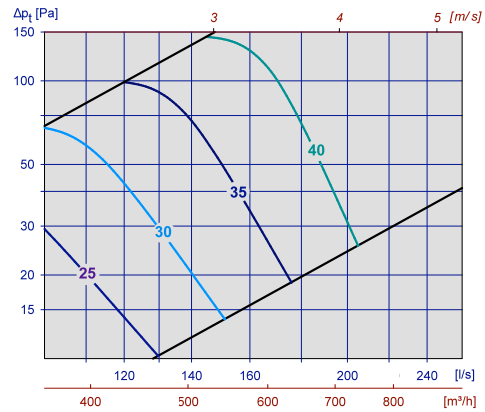

Diagram 17, UPK-R m / ATK-B 400x150 Ø250

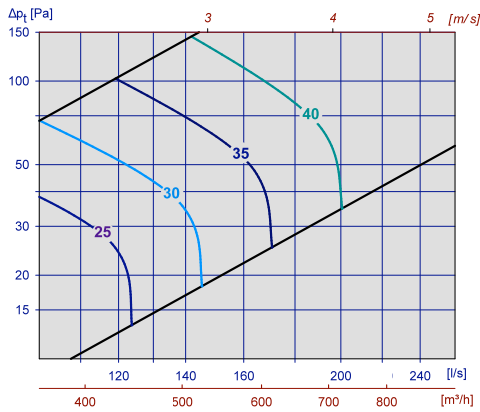

Diagram 18, UPK-R m / ATK-S 400x150 Ø250

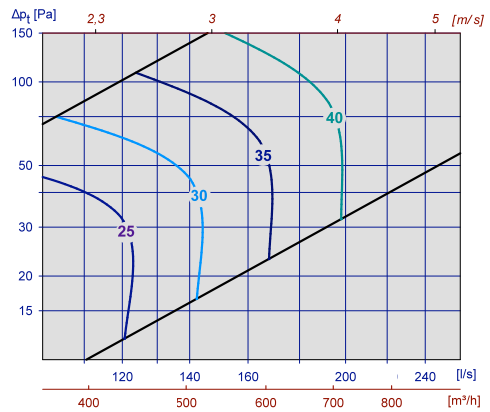

Diagram 19, UPK-R m / ATK-LS 400x150 Ø250

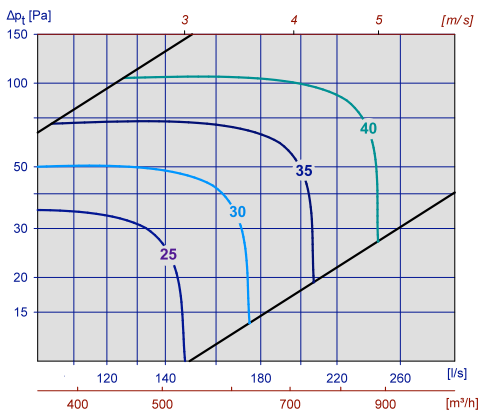

Diagram 20, UPK-R m / ATK-B 500x150 Ø250

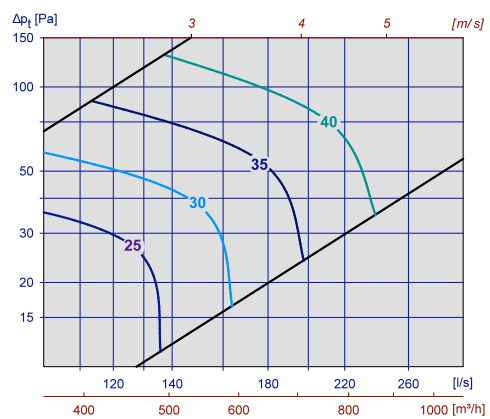

Diagram 21, UPK-R m / ATK-S 500x150 Ø250

UPK

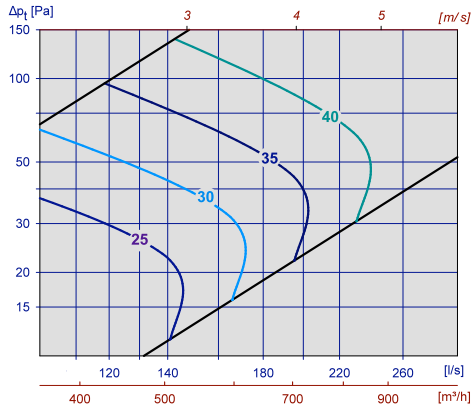

Diagram 22, UPK-R m / ATK-LS 500x150 Ø250

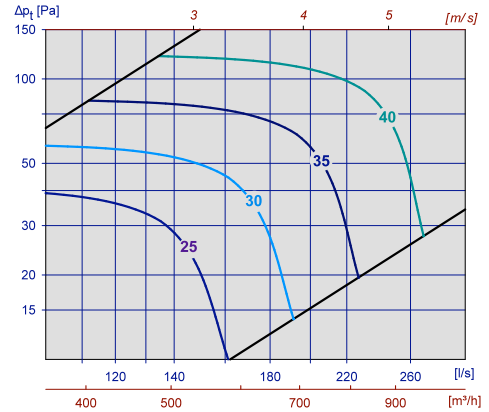

Diagram 23, UPK-R m / ATK-B 400x200 Ø250

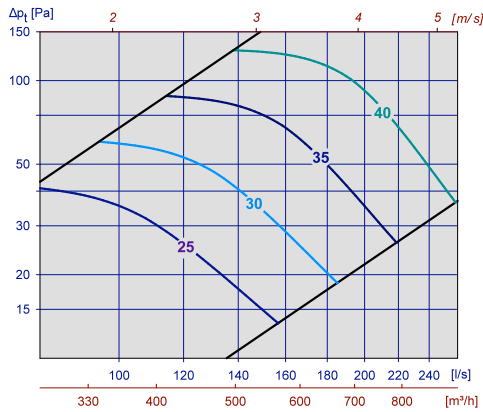

Diagram 24, UPK-R m / ATK-S 400x200 Ø250

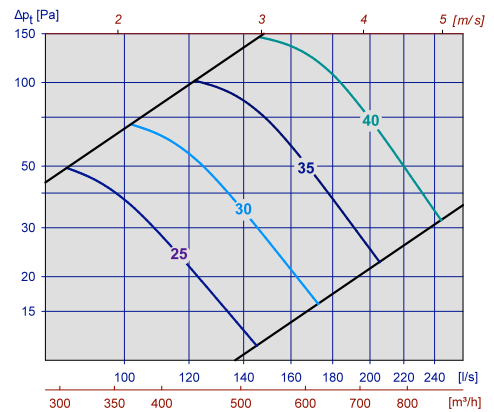

Diagram 25, UPK-R m / ATK-LS 400x200 Ø250

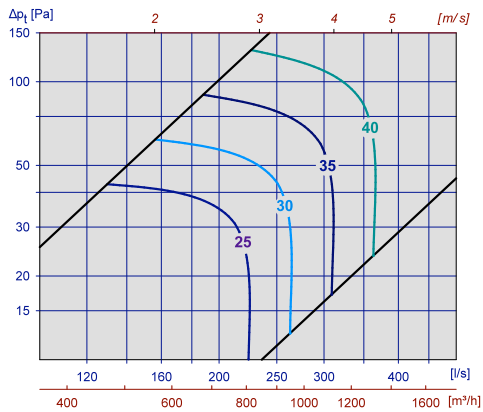

Diagram 26, UPK-R m / ATK-B 500x200 Ø315

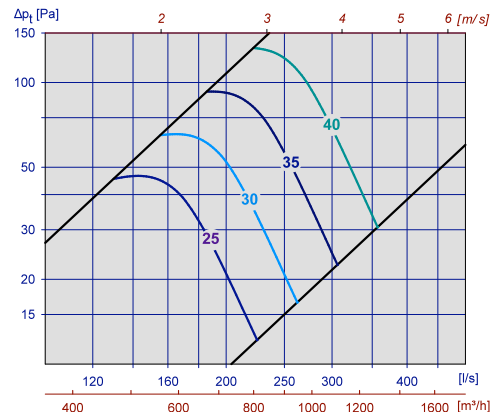

Diagram 27, UPK-R m / ATK-S 500x200 Ø315

UPK

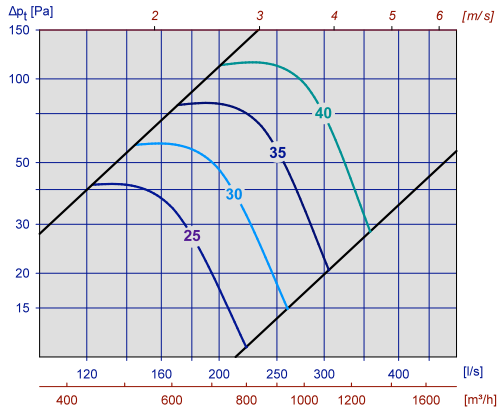

Diagram 28, UPK-R m / ATK-LS 500x200 Ø315

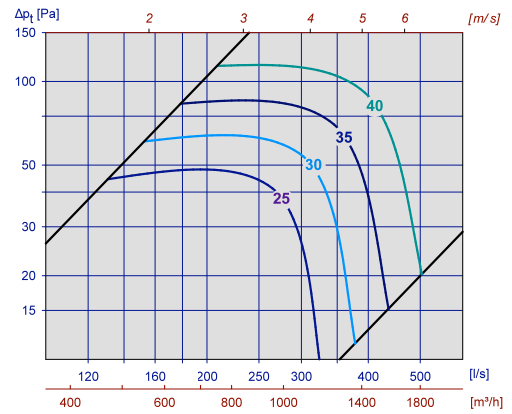

Diagram 29, UPK-R m / ATK-B 500x300 Ø315

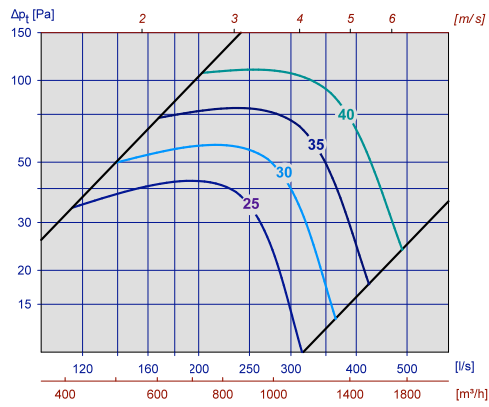

Diagram 30, UPK-R m / ATK-S 500x300 Ø315

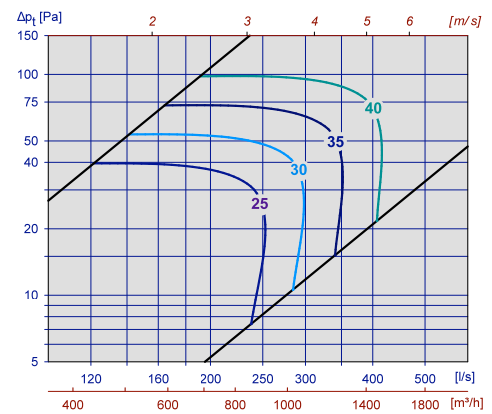

Diagram 31, UPK-R m / ATK-LS 500x300 Ø315

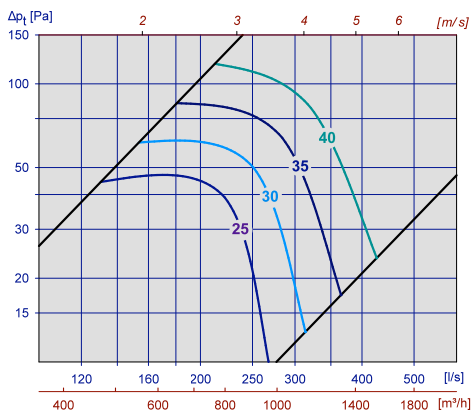

Diagram 32, UPK-R m / ATK-B 600x200 Ø315

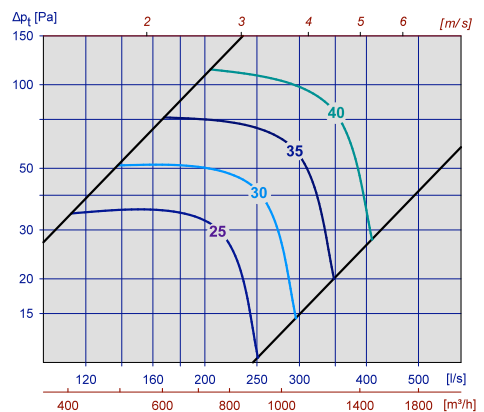

Diagram 33, UPK-R m / ATK-S 600x200 Ø315

UPK

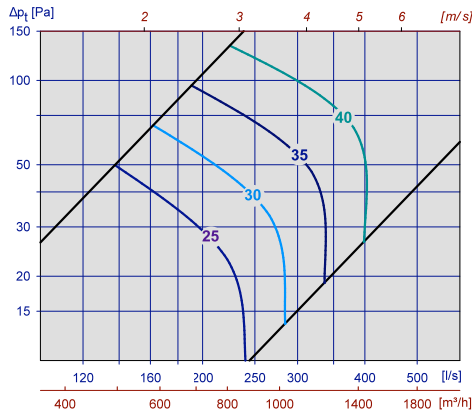

Diagram 34, UPK-R m / ATK-LS 600x200 Ø315

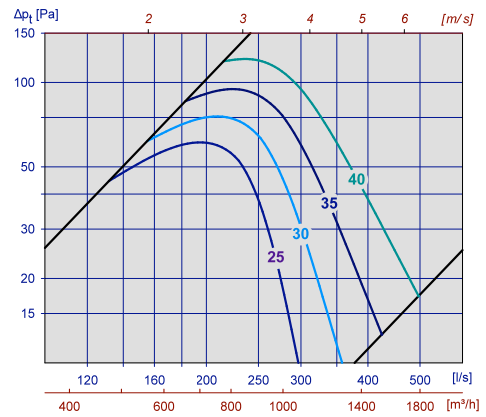

Diagram 35, UPK-R m / ATK-B 600x300 Ø315

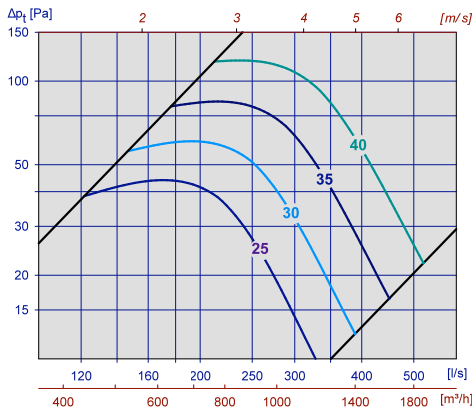

Diagram 36, UPK-R m / ATK-S 600x300 Ø315

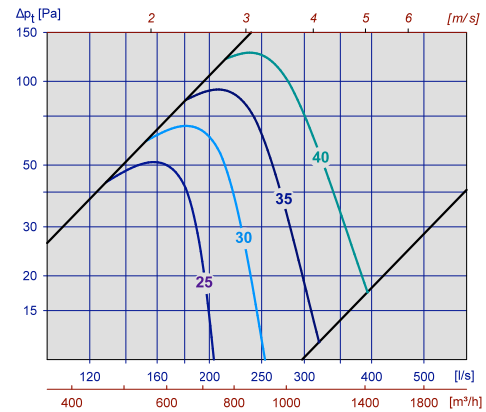

Diagram 37, UPK-R m / ATK-LS 600x300 Ø315

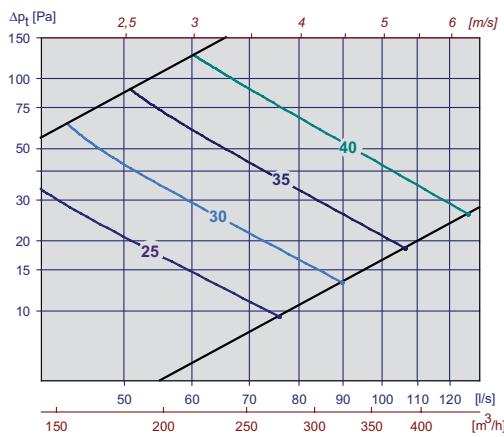

Diagram 38, UPK-R m / ATK-H-B 600x600 Ø160

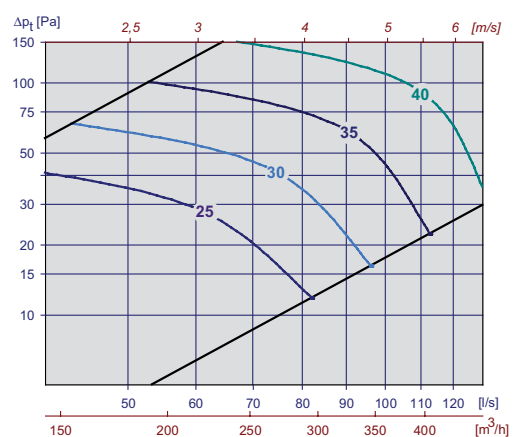
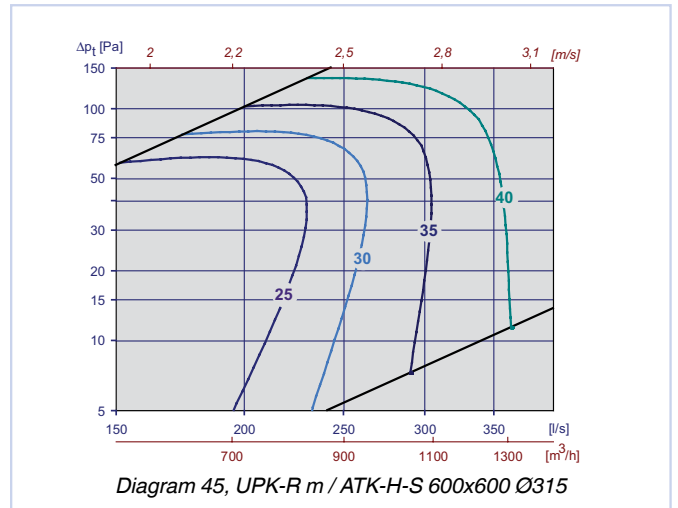
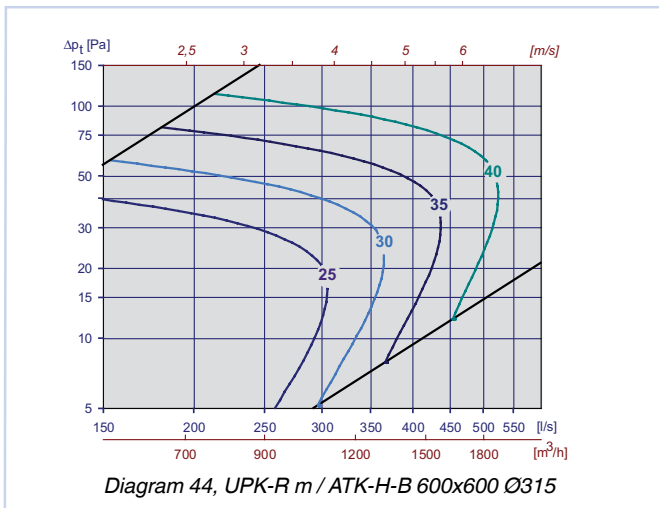
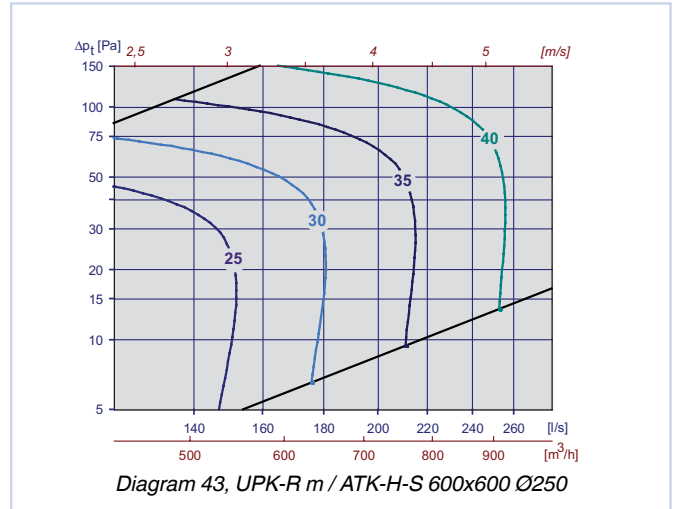
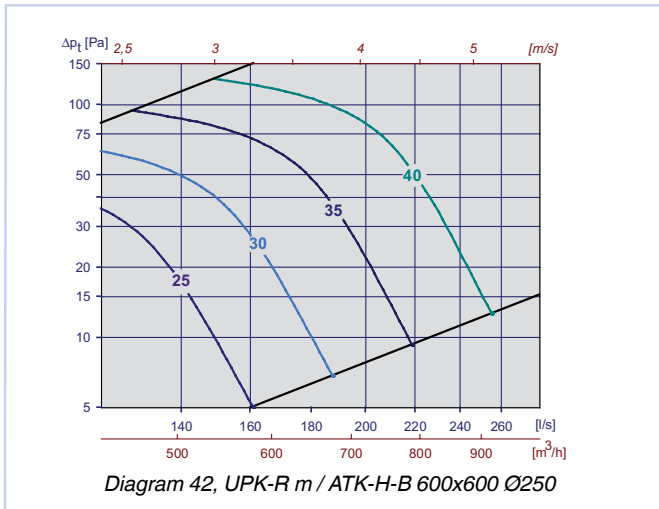
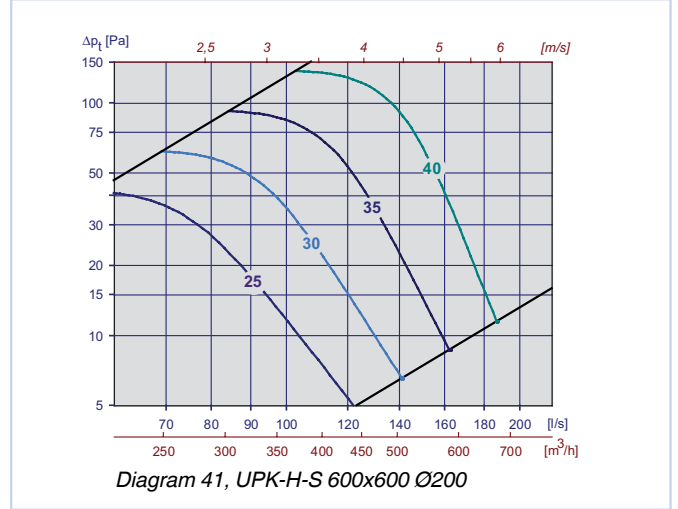
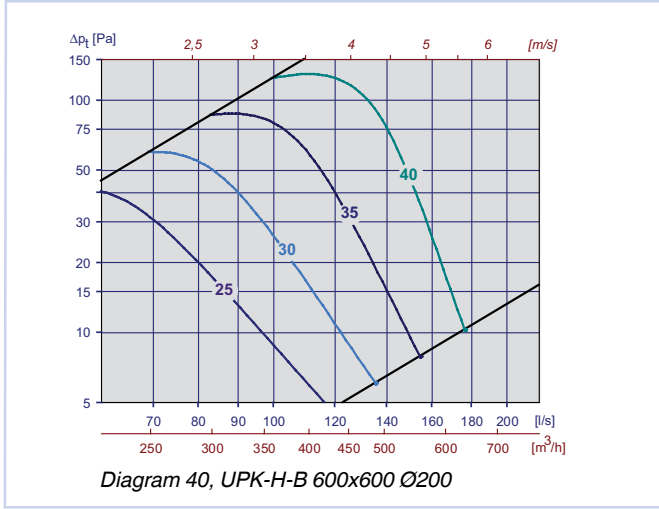

Diagram 39, UPK-R m / ATK-H-S 600x600 Ø160

UPK



UPK

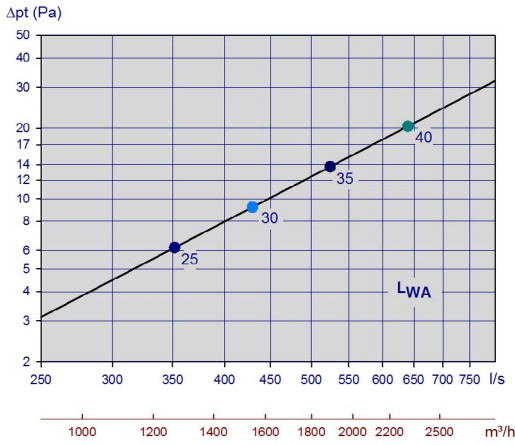

Diagram 46, UPK-R m / ATK-H-B 600x600 Ø400

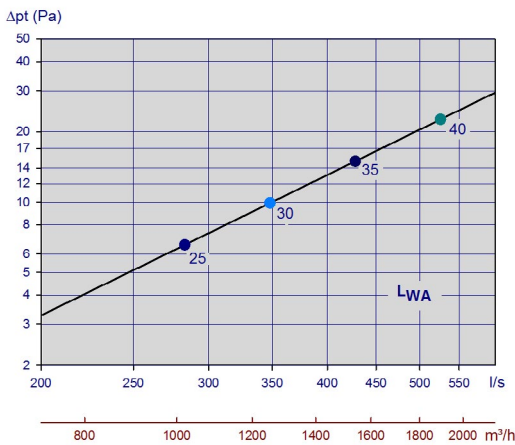

Diagram 47, UPK-R m / ATK-H-S 600x600 Ø400

Statisk lydemping inkl. enderefleksjon for UPK-R og UPK-H med kammer

UPK-R/H	ATK-kammer		Demping [dB]							
	B x H	Dim. Anslutning	63	125	250	500	1k	2k	4k	8k
200x100	125	B	20	13	11	10	6	7	4	4
200x100	125	S	20	13	11	12	11	5	4	1
200x100	125	LS	22	12	12	14	12	8	11	13
300x100	160	B	19	11	9	8	5	7	3	1
400x100	160	B	17	11	9	9	9	9	4	5
300x100	160	S	20	12	10	16	14	11	9	12
400x100	160	S	18	10	10	13	13	9	9	11
300x100	160	LS	19	13	10	14	12	8	13	13
400x100	160	LS	19	11	11	12	8	4	6	1
500x100	200	B	15	8	11	10	8	4	2	0
300x150	200	B	16	8	9	7	6	1	0	-4
500x100	200	S	15	9	11	12	9	8	7	3
300x150	200	S	17	8	9	12	8	7	7	3
500x100	200	LS	16	9	14	14	8	6	7	4
300x150	200	LS	17	8	11	14	8	8	9	6
400x150	250	B	14	10	9	9	13	6	4	4
500x150	250	B	13	10	10	9	10	3	2	2
400x200	250	B	13	10	8	7	10	3	1	0
400x150	250	S	14	10	13	14	13	7	9	7
500x150	250	S	14	9	13	13	11	7	8	10
400x200	250	S	15	9	11	13	11	7	8	8
400x150	250	LS	16	10	12	10	6	2	3	0
500x150	250	LS	14	10	13	14	9	9	11	12
400x200	250	LS	15	10	11	11	8	6	8	7
500x200	315	B	9	10	8	9	10	5	3	3
600x200	315	B	8	10	9	10	10	5	3	3
500x300	315	B	10	9	9	10	9	8	5	6
600x300	315	B	8	8	7	8	8	3	2	1
500x200	315	S	11	9	11	11	11	7	7	7
600x200	315	S	10	9	10	9	10	8	9	9
500x300	315	S	11	8	10	12	11	9	9	10
600x300	315	S	11	8	10	12	11	7	7	8
500x200	315	LS	11	10	13	11	9	9	10	9
600x200	315	LS	10	10	13	12	7	6	4	4
500x300	315	LS	10	9	11	11	8	9	10	8
600x300	315	LS	10	9	11	11	7	7	7	6
600x600	160	S	19	9	7	9	8	4	6	10
600x600	200	S	17	7	7	9	7	4	7	10
600x600	250	S	14	5	6	11	6	5	8	11
600x600	315	S	13	3	6	11	4	5	9	11
600x600	400	S	11	2	5	11	3	6	10	12
600x600	160	B	17	8	7	8	3	2	1	2
600x600	200	B	16	6	6	8	3	1	1	1
600x600	250	B	15	4	5	8	3	2	1	1
600x600	315	B	13	2	5	9	3	1	1	1
600x600	400	B	11	1	4	9	3	1	1	1

Tabell 7

UPK

KO faktorer [KO], for UPK-R og UPK-H med ATK kammer

UPK-R/H	ATK-kammer		KO [dB]															
			Stengt spjæld								Åpent spjæld							
B x H	Dim.	Anslutning	63	125	250	500	1k	2k	4k	8k	63	125	250	500	1k	2k	4k	8k
200x100	125	B	0	-7	-4	-5	-5	-16	-8	-6	1	-4	-5	-7	-6	-7	-9	-14
200x100	125	S	-4	-5	-2	-6	-9	-13	-6	-5	-3	-5	-4	-5	-5	-7	-10	-12
200x100	125	LS	0	-4	-2	-6	-9	-10	-6	-6	-1	-5	-4	-5	-5	-8	-11	-12
300x100	160	B	-8	-6	-6	-7	-9	-15	-5	-5	-1	-6	-2	-4	-5	-10	-12	-10
400x100	160	B	-8	-5	-7	-7	-11	-14	-5	-4	-3	-4	-4	-5	-4	-8	-12	-14
300x100	160	S	-7	-4	-4	-9	-11	-11	-5	-5	-2	-4	-4	-5	-4	-8	-11	-13
400x100	160	S	-5	-3	-5	-9	-14	-12	-5	-4	-1	-2	-3	-6	-4	-7	-12	-14
300x100	160	LS	-6	-4	-5	-9	-12	-9	-5	-5	-1	-4	-2	-4	-4	-9	-12	-12
400x100	160	LS	-6	-3	-5	-11	-13	-8	-5	-5	-2	0	-2	-6	-6	-7	-10	-13
500x100	200	B	-1	-3	-8	-9	-16	-11	-5	-4	0	-2	-5	-4	-4	-9	-14	-13
300x150	200	B	-7	-4	-6	-7	-15	-12	-5	-3	-5	-4	-4	-4	-4	-8	-13	-13
500x100	200	S	-5	3	-4	-8	-11	-9	-6	-5	-5	0	-5	-5	-4	-9	-13	-13
300x150	200	S	-6	0	-5	-10	-13	-10	-5	-4	-6	-4	-6	-7	-5	-7	-10	-16
500x100	200	LS	-6	0	-5	-11	-9	-9	-6	-4	-1	1	-3	-3	-4	-11	-13	-11
300x150	200	LS	-7	0	-5	-10	-6	-7	-7	-7	-3	-2	-2	-5	-5	-9	-11	-13
400x150	250	B	-2	-4	-7	-6	-13	-11	-6	-4	0	-4	-5	-5	-4	-7	-11	-15
500x150	250	B	-4	-5	-7	-6	-15	-11	-5	-4	-1	-2	-4	-3	-4	-11	-14	-12
400x200	250	B	-8	-1	-5	-5	-15	-12	-5	-4	-5	-1	-3	-4	-4	-10	-13	-12
400x150	250	S	-4	-1	-6	-8	-10	-8	-6	-5	1	-2	-4	-4	-4	-8	-13	-13
500x150	250	S	2	-1	-8	-10	-10	-8	-5	-5	1	2	-2	-3	-5	-11	-13	-10
400x200	250	S	-6	1	-4	-9	-11	-10	-5	-5	-3	2	-3	-4	-4	-9	-13	-13
400x150	250	LS	2	-2	-7	-8	-6	-10	-7	-5	0	-1	-3	-5	-4	-8	-13	-14
500x150	250	LS	0	-2	-7	-9	-7	-10	-7	-5	3	0	-4	-5	-3	-9	-14	-14
400x200	250	LS	-7	0	-5	-8	-6	-10	-7	-6	-1	2	-4	-5	-3	-11	-14	-13
500x200	315	B	-7	-5	-7	-8	-11	-9	-5	-6	-4	-4	-6	-4	-5	-8	-12	-13
600x200	315	B	-6	-6	-8	-10	-12	-7	-5	-6	-5	-4	-6	-4	-4	-8	-14	-16
500x300	315	B	-5	-5	-7	-7	-14	-9	-5	-5	-6	-3	-7	-4	-4	-8	-12	-16
600x300	315	B	-12	-7	-7	-9	-14	-10	-5	-4	-7	-3	-8	-6	-6	-6	-9	-15
500x200	315	S	-7	-2	-9	-11	-10	-8	-5	-6	-4	-2	-6	-5	-5	-7	-12	-15
600x200	315	S	-1	-2	-8	-10	-10	-8	-5	-6	0	0	-4	-3	-5	-10	-14	-12
500x300	315	S	-11	-7	-13	-13	-10	-8	-5	-6	-7	-4	-8	-5	-5	-6	-11	-16
600x300	315	S	-11	-6	-11	-13	-10	-8	-5	-6	-5	-3	-7	-6	-5	-7	-11	-14
500x200	315	LS	-5	-3	-10	-10	-7	-9	-6	-6	-3	-1	-7	-4	-4	-8	-13	-15
600x200	315	LS	-7	-5	-11	-11	-5	-9	-7	-7	-1	-1	-5	-3	-3	-10	-15	-15
500x300	315	LS	-12	-8	-13	-12	-7	-7	-6	-7	-5	-1	-8	-5	-3	-8	-13	-16
600x300	315	LS	-10	-5	-11	-12	-8	-9	-5	-5	-5	-3	-10	-6	-2	-10	-13	-14
600x600	160	S	0	-6	-2	-6	-11	-7	-7	-8	1	-6	-6	-12	-2	-7	-17	-18
600x600	200	S	0	-1	-1	-4	-7	-8	-9	-11	1	-5	-8	-12	-2	-8	-17	-18
600x600	250	S	-6	-3	-3	-8	-6	-7	-8	-10	-10	-9	-11	-14	-7	-4	-9	-21
600x600	315	S	-7	-5	-6	-10	-6	-6	-8	-10	-7	-8	-11	-4	-2	-12	-19	-22
600x600	400*	S	-	-	-	-	-	-	-	-	6	4	-3	-4	-5	-7	-16	-18
600x600	160	B	-3	-6	-2	-7	-7	-8	-7	-7	-2	-7	-7	-15	-3	-5	-16	-20
600x600	200	B	1	0	0	-3	-6	-9	-10	-12	-1	-7	-10	-16	-1	-11	-19	-20
600x600	250	B	-4	-2	-5	-5	-9	-8	-7	-7	-1	-2	-5	-5	-4	-6	-17	-20
600x600	315	B	-4	-2	-3	-7	-8	-7	-6	-9	-5	-7	-10	-7	-4	-7	-15	-21
600x600	400*	B	-	-	-	-	-	-	-	-	8	10	1	-3	-10	-12	-12	-12

Tabell 8 (*Ø400 uten spjæld)

UPK

MONTERING

ATK kammer og montasjeramme sammenmonteres som vist i figur 10, deretter plasseres avtrekksristen inn i montasjeramme. Montasjeprinsipp for ATK-H er vist i figur 11.

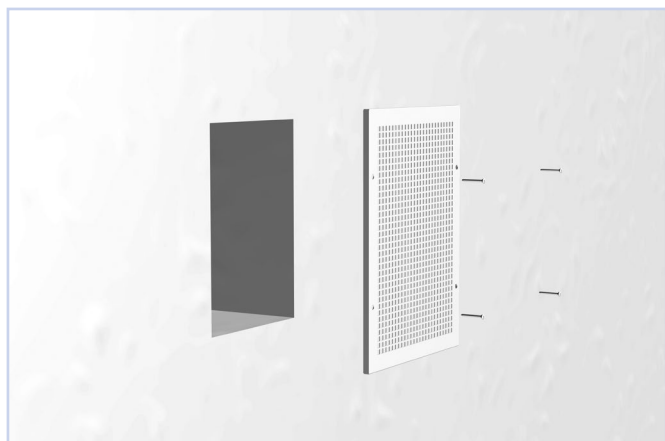

Figur 9, montasje UPK BxH

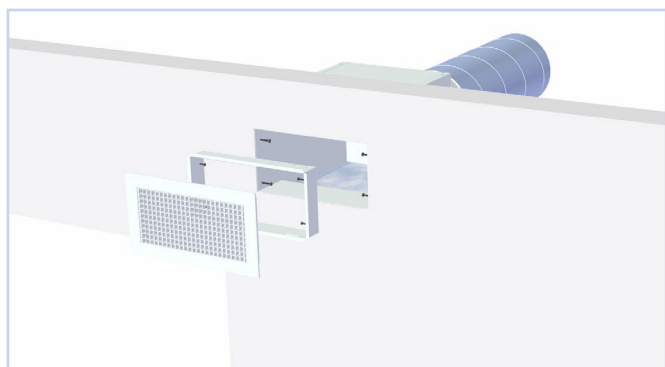

Figur 10, montasje UPK-R med ATK kammer.

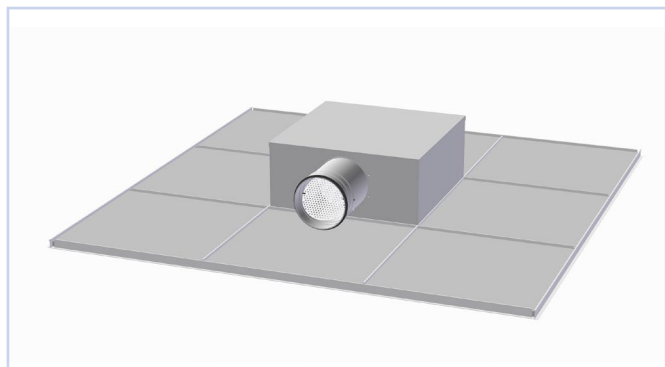

Figur 11, montasje ATK-H.

INNREGULERING

Ved innregulering må ventilfronten være påmontert. Reguleringsviren trekkes ut gjennom fronten. På ATK-B, S eller LS trekkes også måleslangen ut gjennom fronten. Spjeldet låses med låsemutter på wiren, husk å skru låsemutteren skikkelig til slik at spjeldet ikke endrer stilling. **For innregulering av UPK BxH anbefales separat måle- og reguleringsenhet**

VEDLIKEHOLD

Ventilen rengjøres med en fuktig klut. Ved rensing av kanalnettet fjernes ventilfronten for å komme til kanalen. Dersom Luna benyttes, demonteres fordelingsplaten og spjeldet for fri tilgang til kanalen.

MILJØ

Forespørsel vedrørende byggvaredeklarasjon kan rettes til en av våre selgere, eller finnes på vår hjemmeside: www.trox.no

UPK er utviklet og produsert av:

Retten til endringer forbeholdes.